

METALLIC RECTIFIER DESIGN AND APPLICATION

JULIAN
LOEBENSTEIN

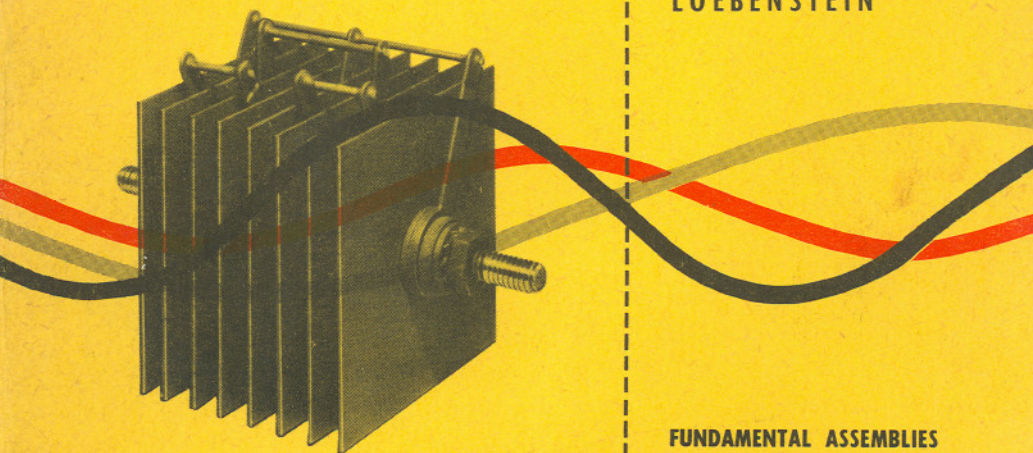

FUNDAMENTAL ASSEMBLIES
CENTER-TAP, BRIDGE AND
DOUBLER CIRCUITS
POLARITY DESIGNATION
REVERSE VOLTAGE RATINGS
AC-DC VOLTAGE RATIOS
RELATIVE ADVANTAGES OF
VARIOUS TYPES



RADIO RECEPTOR COMPANY, INC.

METALLIC RECTIFIER DESIGN AND APPLICATION

JULIAN LOEBENSTEIN

foreword

Although metallic rectifiers have been in general use for a period of ten or fifteen years, it is only within the past few years that the field of application has been broadened to the extent that their use is being considered by many who until recently, were scarcely aware that they were available. This trend has been due to their general application in radio and television, and their assembly in units capable of delivering many kilowatts. As a result, there has appeared an assortment of data covering various phases of the rectifiers' characteristics. However, there still remain certain elementary matters which appear to be puzzling to the new metallic rectifier user, and even engineers experienced in electronic circuits occasionally overlook some factor in their application . . . The following pages, then, will attempt to clarify the subject.

Reprinted by courtesy of Service Magazine

SELETRON DIVISION
RADIO RECEPTOR COMPANY, Inc.



Since 1922 in Radio and Electronics



SALES DEPARTMENT: 251 WEST 19TH STREET • NEW YORK 11, N. Y.
FACTORY: 84 NORTH 9TH STREET • BROOKLYN 11, N. Y.

Characteristics of Fundamental Assemblies . . .

Bridge Circuits, Doubler

Fundamental Assembly

The fundamental building block of metallic rectifiers is a single cell or plate. This, when placed in an *ac* circuit, causes half-wave rectification in the same manner as a check valve placed in a water line would permit the water to flow in one direction only, if water were pulsing back and forth in the pipe. As each cell is capable of withstanding only a given voltage before puncturing, it is necessary to put more cells in series as the voltage increases. This would be the same as an increase in the thickness of the flapper of the valve to enable it to withstand a higher water pressure.

In Figs. 1 and 2, these assemblies are illustrated. Schematic diagrams of rectifier circuits do not as a rule indicate a multiplicity of plates but merely show the conventional rectifier symbol, regardless of the voltage. Current in the conventional sense, i.e., not electron flow, is considered to be in the direction in which the symbol points. Fig. 3 shows the half-wave rectification obtained in this manner.

Reverse Voltage

The voltage mentioned above, which the cell is capable of withstanding before puncturing, is sometimes considered as the reverse voltage. Actually it does not correspond with the reverse voltage rating which the manufacturer gives to the cell, as will be evident from the following explanation.

Reverse Current

The reverse voltage of a rectifier cell is associated with the reverse current. The reverse voltage, as has already been explained, corresponds to the pressure against the flapper of the valve when it is closed. The reverse current may be considered as similar to the back leakage through a check valve which would occur when the flapper does not seat perfectly.

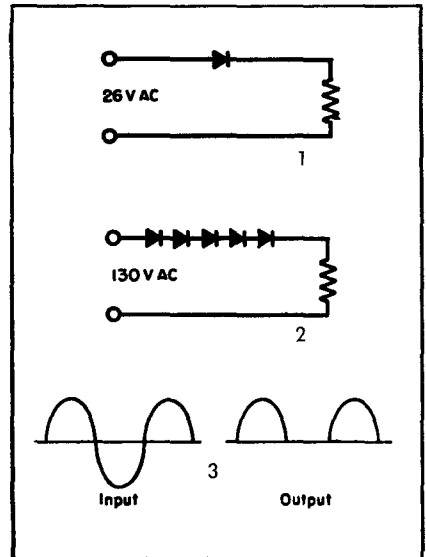

Figs. 1, 2 and 3. Fundamental circuits of half-wave metallic rectifier assemblies appear in Figs. 1 and 2. Fig. 3 illustrates a half-wave rectification waveform.

All metallic rectifiers permit some reverse current to flow. This reverse current is influential in determining the reverse voltage rating of the cell. The reason for this is that heat is generated both by the forward and by the

Properties of Parallel Assemblies, Center-Tap and Arrangements . . . Capacitive Setups

reverse current. Accordingly, the reverse voltage is set at such a value as to limit the amount of reverse current and correspondingly, the heat loss incident to its flow. In all cases the cell can withstand a higher voltage if puncture alone is considered. For instance, if a selenium cell, rated at 26 volts

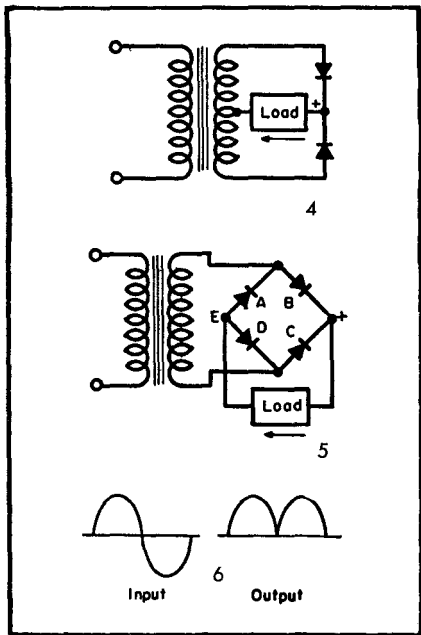

Figs. 4, 5 and 6. Center-tap and bridge circuit systems, shown in Figs. 4 and 5, illustrating that current flows first through one-half of the rectifier and then through the other half, resulting in full wave rectification. Fig. 6 shows input and output waveforms.

reverse, were carrying no forward current, it would suffer no corresponding heating effect. It could therefore be subjected to a higher reverse voltage of possibly 30 or more volts. It can thus be seen that momentary surges within reasonable limits will not puncture the cell.

Half-Wave Assemblies

The half-wave element may be assembled in various combinations to give full-wave rectification which in single phase may be either a center tap circuit or a bridge circuit. The bridge is often designated as a full-wave bridge, but either the center tap circuit or the bridge circuit yields full-wave rectification and the addition of *full-wave* to either term is not necessary. Similarly the half-wave element may be used in three-phase or other multi-phase rectification in various circuits.

It is not difficult to see that in either the center-tap circuit or the bridge circuit, current is permitted to flow first through one-half of the rectifier and then through the other half of the rectifier giving full-wave rectification. Figs. 4 and 5 and 6 illustrate this point. Often, however, many wonder how the mechanical assembly of cells or plates on a stud corresponds to the schematic of the bridge shown in Fig. 5. This may be easily understood if the bridge in Fig. 5 is considered to be opened at point *E*, and arranged in a straight line resulting in an assembly shown in Fig. 7A and *B* in which the individual elements are marked to correspond with those in Fig. 5. When a stack is so assembled the *ac* terminals are color coded yellow, or marked *ac*, whereas the *dc* terminals are respectively color coded red (positive) and black (negative), or marked respectively + and -.

A rectifier stack, as illustrated in Fig. 7A, need not be limited to four cells, but that this could represent any number of cells in series for each element *A*, *B*, *C* and *D* up to the number beyond which the assembly would be

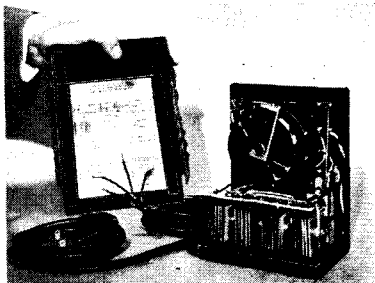

Compact speed control built by General Radio Co., Cambridge, Mass. for applications requiring up to approx. 1/15 H.P. output. Employs Seletron miniatures.

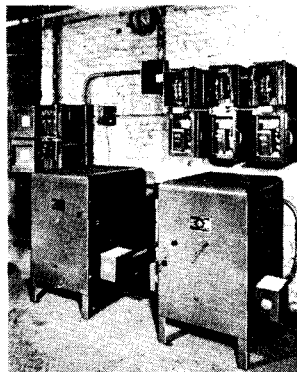

Elevator rectification — 3 bank power supply and regenerative braking equipment employing Seletron rectifiers, built for Clinton Realty Co., Chicago, by Ther Electric & Machine Works.

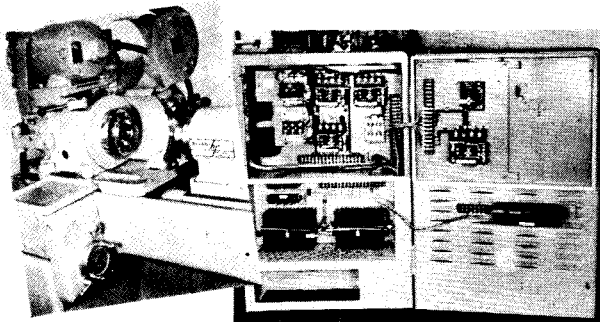

Internal Grinder produced by Bryant Chucking Grinder Co., Springfield, Vt., equipped with 3/4 H.P. D.C. motor. Seletron power stacks making motor suitable for operation on standard A.C. current, are incorporated into design.

Illustrated on this page are a few plating, battery charging, and power assemblies developed by customers of



SELENIUM RECTIFIERS

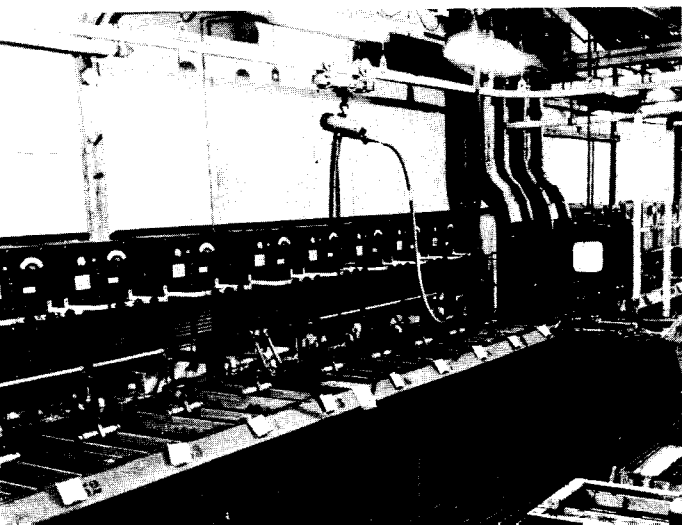

Installation of Plating equipment by Richardson-Allen Corporation, College Point, N. Y. Rectifiers are each rated at 12 volts, 1500 amperes. Remote control.

come cumbersome. After that point it would be necessary to break the stack into a group of stacks which might, for example be two stacks, each consisting respectively of *A* and *B* combined, and *C* and *D* combined. On the other hand it might consist of four separate stacks with the elements *A*, *B*, *C* and *D* each assembled on its own stud. This breakdown could be carried out further if the total cells should require it.

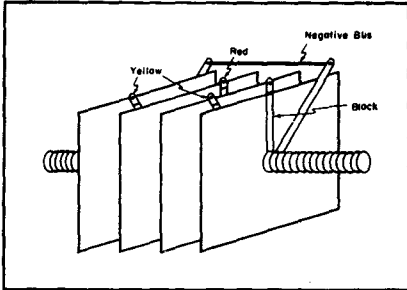
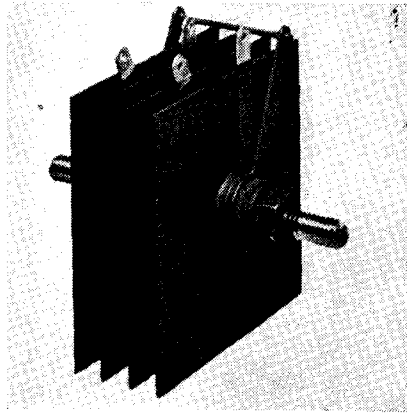

Fig. 7A. Drawing (above) and photo (below) of typical assembly of plates, arranged to correspond to the schematic shown in Fig. 5.



Cells in Parallel

Rectifier cells are available in different sizes whose current rating increases with the size of the cell. However, the amperes per square inch of cell area remain approximately the same regardless of the size of the cell.

It is more economical as current requirements increase to go to larger cells than to use additional cells in parallel. However, when the current desired is greater than the current carrying capacity of the largest available cell, there is nothing left but to use as many cells in parallel as may be needed to carry the current. This

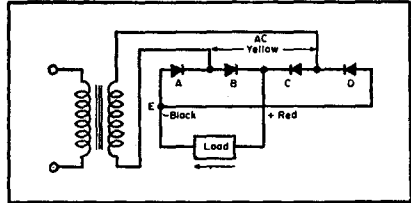

Fig. 7B. Electrical representation of arrangement shown above in Fig. 7A.

current often runs into thousands of amperes.

In the previous description it was shown how cells could be assembled in series. It is not at first glance obvious how the cells may be assembled in parallel. Actually, however, it is a simple matter. If, for instance, a bridge circuit is being considered, it involves merely connection of two or more individual bridge circuits in parallel. This is shown schematically in Fig. 8B and in the illustrations of Fig. 8A, which shows two parallel plates and thus calls for two bridge circuits. The elements *A*, *B*, *C* and *D* constitute one bridge and the elements *A*₁, *B*₁, *C*₁, and *D*₁ constitute another. It will be noticed that the elements *A* and *B* are separated from the elements *C* and *D*. By arranging the cells in this manner, the connecting bus arrangement is simpler than it would be if two bridge stacks were assembled side by side. Cell *A* is connected in parallel with cell *A*₁ and cell *B* with cell *B*₁, etc. Such a stack could however also be made of a combination of series and parallel cells, or in turn of a group of stacks as might be required to carry the particular load.

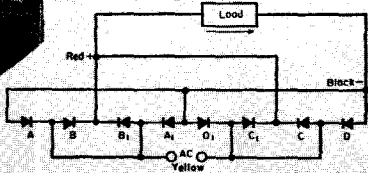
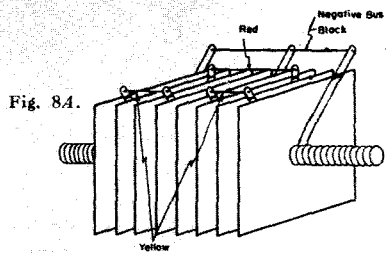
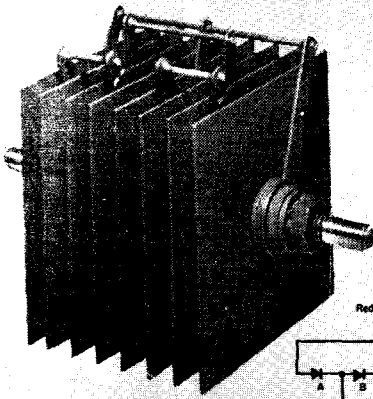

Fig. 8A. Photograph (left) and drawing (upper right) of assembly of two sets of parallel plates set up for dual bridge-circuit use, as illustrated in schematic drawing at lower right, Fig. 8B.

Center Tap Versus Bridge Circuits

Reference has been made to center tap circuits and bridge circuits. The question naturally arises as to their relative advantages and when each should be used. The choice revolves around the input voltage involved. At low voltage the center tap circuit offers economy in both space and cost since it

is necessary to use only half the number of cells which would be required in a bridge circuit. This may be seen from an examination of Fig. 9, in which typical voltage values are given. It is evident that to achieve the same output voltage only two cells are required for the center tap circuit, while four would be needed for the bridge circuit. However, if a slightly higher output voltage is needed (Fig. 10), it would be necessary to have two cells in series in each element of the center tap circuit or a total of four cells, or the same as is used in the bridge.

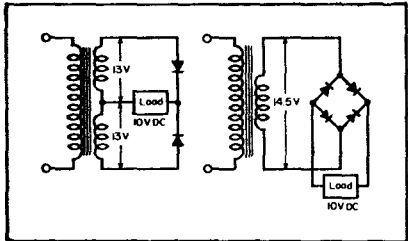

Fig. 9. Bridge and center-tapped circuits with typical voltage values.

Center-Tap Disadvantage

In practice the center-tap circuit loses advantage when the total voltage across the rectifier, i.e., the full secondary voltage exceeds the voltage for which an individual cell is rated. In the foregoing example this is 26 volts.

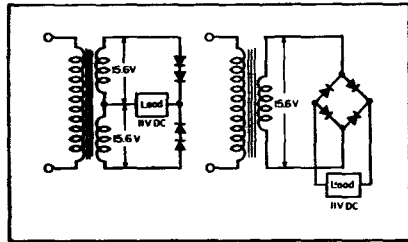
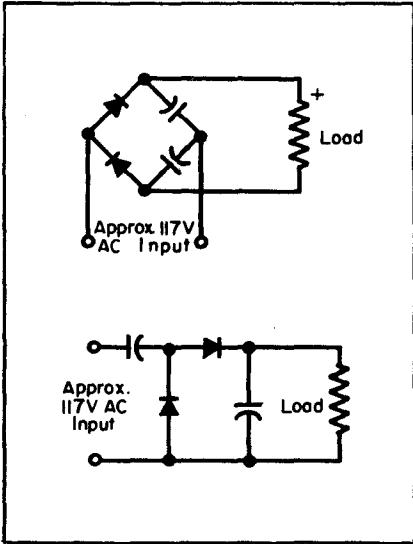

Fig. 10. To secure slightly higher output voltage this arrangement is used; two cells in series in each element of the center tap circuit, or a total of four cells.

This question has been dwelt on at length for two reasons; a bridge circuit is sometimes specified when a center tap circuit would be more advantageous and vice versa. In some cases, engineers who have been using rectifier tubes which carry a considerably higher voltage rating than the individual rectifier cell, have properly been using center-tap circuits. How-

ever, when they consider metallic rectifiers they sometimes overlook the critical values. Either circuit would be equally satisfactory, but when a center-tap circuit is specified where a bridge circuit would suffice, there is involved an additional transformer terminal and a somewhat larger transformer.



Figs. 11 and 12. A symmetrical voltage doubler (above) and series line-feed doubler system.

Doubler Circuits

Possibly the widest application of the selenium rectifier is in the doubler circuit used by many manufacturers of television sets. This circuit, by the use of two rectifier elements and two capacitors, provides an output voltage approximately double that of the voltage input. There are two such types of circuit, shown respectively in Figs. 11 and 12, in simplified circuits without protective resistors or filters. Of these, the circuit shown in Fig. 12 is in wider use.

Doubler Versus Center Tap

It will be noted that the two rectifier elements in each of Figs. 11 and 12 have the same relationships as the two elements *A* and *B* shown in Fig. 5, and constitute half of a bridge circuit. This arrangement of the two elements, shown in Fig. 13, is usually called a doubler, but it is also sometimes known as a half-wave center tap. It is frequently confused with the full-wave center tap shown in Fig. 14. It has appeared with the incorrect designation even in government specifications. It is for this reason that attention has been called to the ease with which one circuit may be confused with the other.

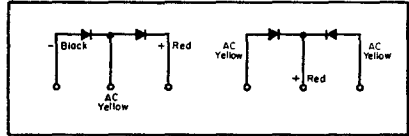

Figs. 13 and 14. At left we have a doubler system often referred to as half-wave center-tap arrangement. A center-tap or full-wave circuit is shown at right.

Capacitive Circuits

It has already been indicated that one of the most popular applications for selenium rectifiers is the doubler circuit which involves a capacitive circuit. Another circuit, in general use in portable three-way (*ac-dc-battery*) and in small table-model radio

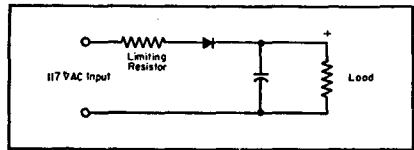

Fig. 15. Half-wave rectification setup which feeds into a capacitive system; used in three-way portables and table-model sets.

sets, involves half-wave rectification into a capacitive circuit, as shown in Fig. 15. This circuit, as well as the



**HERMETICALLY
SEALED
RECTIFIERS**

Hermetically sealed rectifiers are occasionally applied to military and naval uses, and for such uses are constructed to stand shock test as well as temperature-humidity cycles. In general, each rectifier is specifically designed for its particular application.

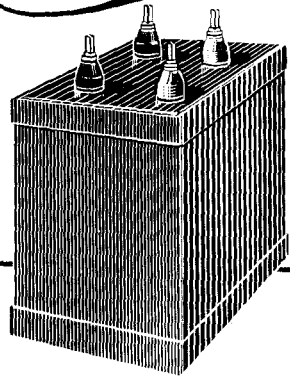

**CARTRIDGE TYPE
with Pigtail Leads**



Diameter: .375"
Pigtails: 1 3/8" long

Half-wave and doubler stacks are available in 5 MA in voltages up to 1300V resistive load; 650V capacitive load. Center tap stacks available at 10 MA, 1300V.



Approx. Width	Approx. Thickness	Length - Listed Below	Pigtails
13/16"	9/16"		3/8" long

doubler circuits previously described, requires a limiting resistor. Before probing the need for this resistor, let us consider the general conditions existing in a rectifier circuit with a capacitive load.

Resistive-Capacitive Loads

In a circuit feeding rectified current into a resistive load, the relationship between the current and the voltage is as shown in Fig. 16. However, when a voltage is impressed across a capacitor, the capacitor builds up a counter electromotive force. It is only when the impressed voltage exceeds the counter electromotive force that current will flow. This is shown in Fig. 17. Since there is little or no resistance between the rectifier and the capacitor, the current flowing into the capacitor can reach rather high peak values. An examination of Figs. 16

and 17 discloses that for the same average value of current, which is the useful *dc* ampere output of the rectifier, the *rms* or heating value of the current in the rectifier will be greater in the circuit shown in Fig. 17, than in that shown in Fig. 16. Since it is essential that the rectifier not be overheated, it is desirable to have the same *rms* current for any given size of cell regardless of the type of load, and so for a capacitive load it becomes necessary to reduce the *dc* value. Therefore, the *dc* current rating of any given cell is considered for a capacitive load to be only 80% that of the current rating for a resistive load. In rating the half-wave miniature rectifiers for use in radio and television, this factor has been taken into account by stack manufacturers. These same conditions prevail in battery charging where a similar condition of counter electromotive force exists.

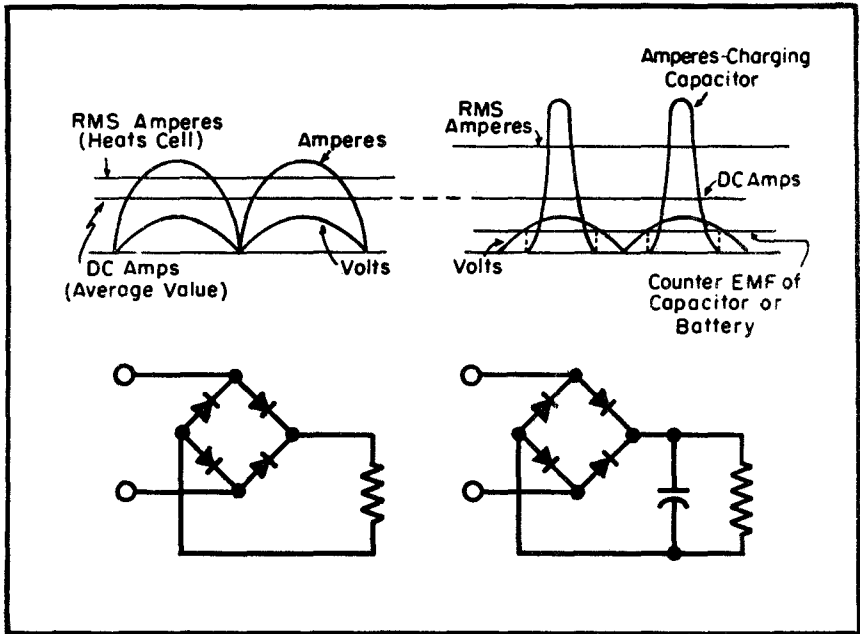

Figs. 16 and 17. In Fig. 16 is illustrated the relationship between current and voltage when feeding rectified current into a resistive load. Fig. 17 shows the capacitive-load circuit and relationship between current and voltage; the rms (amperes) is greater than that appearing in Fig. 16. The *dc* amperes (average value), however, are similar to those of the resistive-load arrangement.

In Fig. 17 the counter *emf* of the capacitor is shown as a straight line. It would actually be a jagged or sawtooth line due to the charging and discharging of the capacitor.

However, since it is the principle involved rather than the detail, and also because when a battery is present a straight line accurately represents the counter *emf*, the straight line may be considered as satisfactorily illustrating what occurs in the circuit.

Use of Large Capacitors

In the case of voltage doubler and half-wave rectifiers (Figs. 11, 12 and 15) operating directly from the 117-volt *ac* lines, it is desirable from the standpoint of capacitor life to use as high a value of capacitance as is economically feasible. This usually results in excessive *rms* current through the rectifier and also gives rise to a very high instantaneous charging current, whenever the circuit happens to be switched on the line at the positive peak of the *ac* wave.

Series Resistors for Surge-Current Control

The introduction of a series resistor effectively reduces the *rms* value of

the current and at the same time limits the maximum instantaneous surge current. In practice, this resistor is of a comparatively low value, ranging from 47 ohms for a 25-milliamperere rectifier to 5 ohms for 250 milliamperes and higher.

Transformer as Limiter

Half-wave and doubler rectifiers supplied from a transformer ordinarily do not require the series resistor, since the transformer usually has enough impedance to limit both the *rms* and peak values of current. This also applies to a center-tap rectifier operating into a capacitive load. It might be advisable however to check the protective value of the transformer impedance.

Bridge Rectifier Connections

Frequently, bridge rectifiers with capacitive input filters are connected directly to the *ac* supply line without a transformer. It might be possible, under certain extreme conditions, to encounter abnormally high *rms* and surge currents in this type of application. However, as a general rule the series resistor is not required.

A PARTIAL LIST OF RECTIFIER APPLICATIONS

FOR USE WITH

ACTUATING MAGNETS

Circuit breakers
Relays
Signal Circuits
Clocks
Chucks for grinders
Business machines
Vending machines
Games
Vibrators for machines of all kinds, candy making, textile, etc.
Elevator control and braking
Organs

SPECIAL APPLICATIONS

POWER APPLICATIONS

Plating and electrolysis
Battery charging
Power for motors
Motor speed control
Generator fields
Arc lamps and motion picture projectors

DC valves
(a) Polarized relays
(b) Prevent backfeed

Arc suppressor
Laboratory and test purposes
Temperature compensator
Acoustic Shunt
Frequency Multiplier
Static drain
Cathodic protection

COMMUNICATIONS AND

SIMILAR APPLICATIONS

Telegraph circuits
Telephone circuits
Teletypewriters
Alarm circuits
Radio and TV
Power supplies and voltage regulators, etc.
Plate voltages and filament supply
Loud speaker field

Polarity Designations . . . Reverse Voltage Ratings Aging . . . AC-DC Voltage Ratios Relative Advantages of Different Types of Stacks

THE DESIGNATION of polarity in half-wave rectifier stacks has been found to be confusing to many. In this stack, the positive terminal is the one to which current flows within the stack. It is often designated as the cathode and marked *K* as well as $+$. Confusion may arise from the fact that in a diode vacuum tube electrons flow when the anode or plate is positive with respect to the filament or cathode. This electron flow is from the cathode to the plate, but by convention the current flow is opposite to electron flow, i.e., from the anode to the cathode. If a tube is inserted into an *ac* circuit, current will flow out of the cathode. This, as well as the flow in a metallic rectifier, is shown in Fig. 18.

The problem may be clarified if the rectifier is considered as a source of *dc* electromotive force, such as a battery. In that case the cathode is the terminal at which the current leaves the battery and is marked positive.

Reverse Voltage Ratings

It has already been stated that each cell is capable of withstanding only a given voltage before puncture, but this statement requires some additional explanation. When a cell is subjected to an alternating voltage the rectifier cur-

rent will flow in the forward direction, but there will also be a small current which leaks in the reverse direction. The magnitude of this leakage or reverse current will increase as the voltage increases. Since the cell will be heated partly by the forward current,

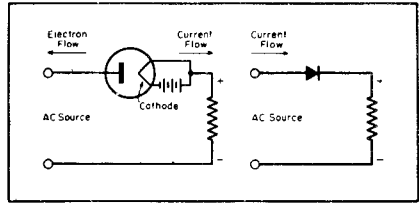

Fig. 18. Circuits illustrating electron flow in tube and metallic-rectifier systems.

and partly by the reverse current, it is desirable to keep the reverse current reasonably small. Generally, therefore, the voltage rating of a cell is based on the number of volts above which an excessive reverse current would flow and overheat the cell. In almost all cases, there is a reasonable margin of safety above this voltage before the cell will puncture and thus fail. For this reason, most rectifiers are able to withstand short line surges without being injured.

Metallic rectifiers will age. This is defined as any persisting change (except failure) which takes place, for

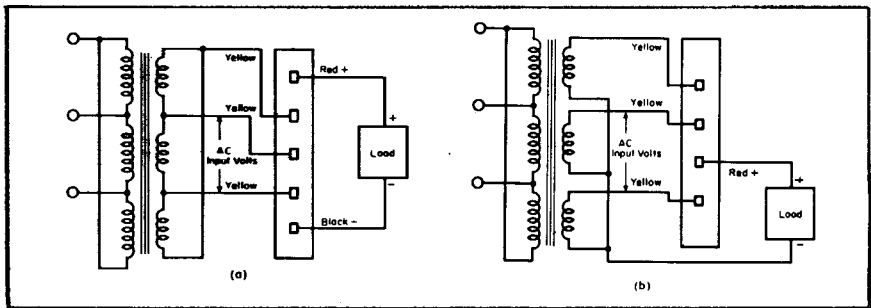

Fig. 19. Three-phase bridge (a) and three-phase half-wave circuits (b).

any reason, in either the forward or reverse resistance characteristic. There is some tendency to age when rectifiers are idle, especially when they are exposed to high temperatures and humidities. Except when they are exposed to extreme conditions, this aging may in general be neglected. However, when rectifiers are in use, aging will take place and in general it is accelerated by temperatures above normal. Likewise, it may be retarded by operation below normal. The individual aging will vary, depending upon the characteristics of the individual rectifiers and the circumstances of their use. Therefore, information on this point should be sought from the manufacturer.

It is obvious that if a rectifier is to be operated at an ambient temperature above that set for its normal rating, its current or voltage rating or both may have to be reduced provided its aging is not to be accelerated. It is desirable, therefore, that some information regarding life expectancy be furnished in specifications calling for increased ambient temperatures. This is a factor often overlooked in specifications written by equipment manufacturers making items for the armed services. In fact, government agencies themselves have been prone to be vague on this point.

Duty Cycles

From the foregoing it may be concluded also that if a rectifier is used intermittently it will run cooler than if used continuously under otherwise identical conditions. This, in turn, means that a smaller rectifier may possibly be used. However, intermittent duty relates only to short-time cycles such as on one minute and off one minute, and not to extended periods such as, on half an hour and off half an hour. For this reason, designations are meaningless when, for

instance, they call for a duty cycle of 50%.

By blowing air across a rectifier, heat is rapidly carried away and thus forced cooling also permits the use of cells at current ratings higher than when cooling is accomplished by natural convection alone.

At the other end of the temperature scale, the rectifier is also affected by extreme cold. But within reasonable limits down to 0°C, the effect of cold may be disregarded. This is because the rectifier has a high resistance at low temperature, but this resistance decreases as the temperature increases. As soon as current starts to flow, the rectifier will usually get warmer with a further decrease in resistance. This continues until a stable condition is reached at a cell temperature reasonably elevated above the ambient temperature.

In using selenium rectifiers, it should also be remembered that the aging characteristics of the half-wave miniature or radio stacks differ considerably from those of the power stacks. The former have a much shorter life for the same operating conditions. But even these radio stacks may be used advantageously for long life under reduced loads or for intermittent duty.

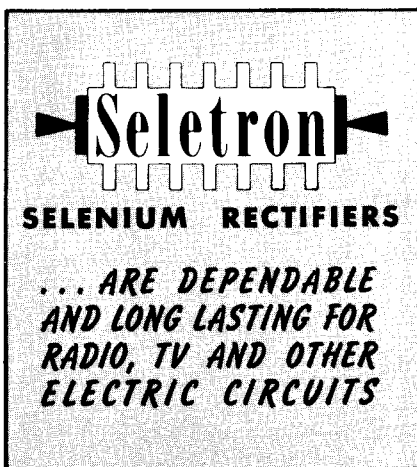

Seletron

SELENIUM RECTIFIERS

**... ARE DEPENDABLE
AND LONG LASTING FOR
RADIO, TV AND OTHER
ELECTRIC CIRCUITS**

AC-DC Voltage Ratios

Sometimes manufacturers are asked to supply a rectifier which, without using a transformer, will give the same output *dc* voltage as the *ac* input line voltage. Circuit conditions, however, do not yield such results.

In a single-phase bridge an *ac* input of 130 volts will yield approximately 105 volts *dc* output. On the other hand, in a three-phase bridge, an *ac* input of 208 volts will give approximately 260 volts output. This type of circuit is frequently used connected direct to the line and without a transformer to supply power, for example, to the solenoids operating contactors on elevator control boards.

In the half-wave, three-phase circuit in which the *ac* voltage is measured to the center of the wye, the voltage conversion is approximately even. An input of 15 volts *ac* will result in approximately 15 volts *dc*. As in the case of the single-phase center-tap circuit, this half-wave, three-phase circuit is best applied to voltages not exceeding the critical cell voltage. This connection is widely used in the electroplating field. Diagrams showing connections for these two types of circuits appear in Fig. 19. In each case a single, three-phase stack is illustrated.

Relative Advantages of Different Types of Stacks

There are, at present, three types of metallic rectifiers in general use: selenium, copper oxide and magnesium copper sulphide. The oxide and sulphide types are sometimes confused with each other because of the use of copper in each. Selenium rectifiers are being more and more widely used because they are available in a higher voltage per cell than are the other two types. Also, most selenium cells are made with aluminum base plates, which results in a lighter stack. How-

ever, one manufacturer of the magnesium copper-sulphide type uses a magnesium base plate which also yields a light stack.

Questions are frequently asked regarding the respective merits of the three types. It is difficult to give a general answer to this, for regardless of the advantage of each type in its particular field, there are some overlapping fields where the various individual merits would have to be weighed in arriving at a decision. This is true also in comparing metallic rectifiers with other means of rectifications such as tubes, motor-genera-

RELATIVE MERITS OF METALLIC RECTIFIERS.

	Copper Oxide	Magnesium Copper Sulphide	Selenium
Withstand high temperature	3	1	2
Weight	2	3 ^B	1 ^A
Efficiency ^C	1	2	1
Reverse voltage per cell	2	3	1
Life	1	2	1
Temporary overload (V) (amperes)	1	3	2
Cost depends upon use		1	3
Deforming when out of use	1	3	2

^A On aluminum.

^B On iron (lightweight with magnesium plate).

^C Depends upon voltage of use. Selenium usually excels for power applications.

Numbers 1-2-3 indicate relative merit, with number 1 highest.

tor sets or mechanical rectifiers. Germanium rectifiers are now also available. However, their use is limited to such extremely small currents, generally in the magnitude of milliamperes; thus they fall in an entirely different class of application from those of the other three types.

In table 1 (p. 13) appears a tabulation citing the relative advantages of each type with respect to various characteristics. In this table, the numbers 1, 2, 3, serve to indicate the relative

merits of the rectifiers in order. The relative ratings must, however, be considered in the light of the particular application.

In general, it may be said that the outstanding advantages of each of the three types of rectifiers are:

Selenium . . . High efficiency, lightweight, high voltage.

Copper Oxide . . . Stable and uniform characteristics. Especially de-

sirable for *dc* valve use, ring rectifiers for modulators and meters. Capable of withstanding large voltage and current overloads for extremely short periods as in reclosing circuit breakers.

Magnesium Copper Sulphide . . . Ability to withstand high temperature for extended periods. Can withstand high current overload. This is essentially a low-voltage high-current device.



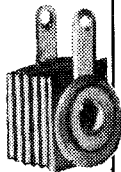
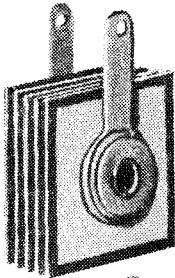

MINIATURE SELENIUM RECTIFIERS
FOR RADIO, TV
AND OTHER APPLICATIONS

T.M. REG. U.S. PAT. OFF.



MODEL NO.	PLATE SIZE	STACK THICKNESS	MAX. INPUT VOLTAGE R. M. S.	MAX. PEAK INVERSE VOLTAGE	MAX. D.C. OUTPUT CURRENT
1M1	1" sq.	3/8"	25	75	100 MA
8Y1	1/2" sq.	9/16"	130	380	20 MA
16Y1	1/2" sq.	15/16"	260	760	20 MA
8J1	1 1/16" sq.	9/16"	130	380	65 MA
5M4	1" sq.	11/16"	130	380	75 MA
5M1	1" sq.	7/8"	130	380	100 MA
5P1	1-3/16" sq.	7/8"	130	380	150 MA
6P2	1-3/16" sq.	1-3/16"	156	456	150 MA
5R1	1 1/2" x 1 1/4"	7/8"	130	380	200 MA
5Q1	1 1/2" sq.	1 1/8"	130	380	250 MA
6Q1	1 1/2" sq.	1 1/8"	156	456	250 MA
6Q2	1 1/2" sq.	1 3/8"	156	456	250 MA
6Q4	1 1/2" sq.	1 3/4"	130	380	300 MA
5QS1	1 1/2" x 2"	1 1/8"	130	380	350 MA
6QS2	1 1/2" x 2"	1 1/4"	156	456	350 MA
5S1	2" sq.	1 1/8"	130	380	500 MA
6S2	2" sq.	1 3/8"	156	456	500 MA

For Listings of Industrial Rectifiers, see page 16.

SELETRON DIVISION | **RADIO RECEPTOR COMPANY, INC.**
Since 1922 in Radio and Electronics
 SALES DEPARTMENT: 251 WEST 19TH STREET • NEW YORK 11, N. Y. 
 FACTORY: 84 NORTH 9TH STREET • BROOKLYN 11, N. Y. 

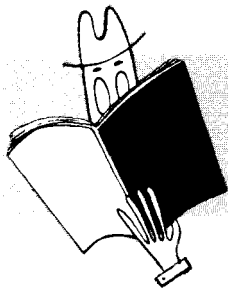

Definitions of a few of the terms used in this article

There are many terms employed in metallic-rectifier design and application, the exact definitions of which have been found to be confusing to many. Accordingly, these terms have been defined as follows:

Metallic Rectifier Cell...A metallic rectifier cell is an elementary rectifying device having one positive, one negative electrode and one rectifying junction. It has the characteristic of conducting current effectively in only one direction. In the past this has been called a disc, plate or junction.

*Rectifying Element**...“A rectifying element is a circuit element which has the property of conducting current effectively in one direction only.”—*NEMA*. (A single-phase bridge circuit, for instance, has four elements. In the past elements have been referred to as arms or legs. A rectifying element may consist of a single cell or of a multiplicity of cells in series, in parallel or in series-parallel.)

Metallic Rectifier Stack...A metallic rectifier stack is a single structure of one or more metallic rectifier cells. (These cells in turn may constitute one or more elements.)

Metallic Rectifier Stack Assembly...A metallic rectifier stack assembly is an assembly of two or more stacks.

*Rectifier**...“A rectifier is an integral assembly of one or more devices, each of which conducts current effectively in only one direction.”—*NEMA*.

*Metallic Rectifier Unit**...“A rectifier unit is an operable arrangement of a rectifier and essential auxiliaries such as transformers, filters, switch-gears, etc.—*NEMA*.

*Cell Combination**...“The cell combination in a metallic rectifier is the arrangement of cells in a stack, stack assembly or rectifier unit. The cell combination is described by a sequence of three numbers, written *a-b-c*, with the following significances:

- (a) Number of rectifying elements.
- (b) Number of cells in series in each rectifying element.
- (c) Number of cells in parallel in each rectifying element.

Note: The total number of cells in the rectifier is the product of these three numbers.”—*NEMA*.

*From Standards for Metallic Rectifiers of the National Electrical Manufacturers Association.

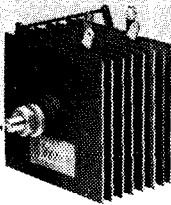

Seletron Selenium Rectifiers are the choice of an increasing number of manufacturers in diversified fields because they are so thoroughly dependable under all types of grueling conditions . . . Available in the miniature sizes required for radio, TV and other electronic circuits, all the way up to heavy duty power stacks used in a wide range of industrial applications.

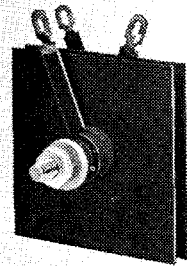

INDUSTRIAL TYPE SELETRON RECTIFIERS STOCKED BY JOBBERS
Single Phase - Full Wave Bridge - Resistive-Inductive Load

D.C. OUTPUT @ 35°C			MAX. INPUT R.M.S. VOLTS	SELETRON RECTIFIER CODE NO.	RECTIFIER PRICE	BRACKETS PRICE EACH
MAX. AMPS.	APPROX. VOLTS NEW	APPROX. VOLTS AGED				
0.9	18	17	24	Q1B1S1B	\$2.40	.17
1.4	19	18	24	S1B1S1B	4.16	.22
3.2	18	17	24	U1B1S1B	6.34	.22
6.0	18	17	24	W1B1S1B	8.82	.28
10.0	18	17	24	H1B1S1B	12.38	.44
20.0	18	17	24	H1B2S1B	23.43	.44
30.0	19	18	24	WH1B3S1B	35.26	.44
0.45	37	35	48	P2B1S1B	5.00	.17
0.9	37	35	48	Q2B1S1B	5.64	.17
1.4	37	35	48	S2B1S1B	7.60	.22
3.2	37	35	48	U2B1S1B	11.25	.22
6.0	37	34	48	W2B1S1B	16.08	.28
10.0	37	34	48	H2B1S1B	22.71	.44
16.0	37	35	48	H2B2S1B	42.73	.44
24.0	37	35	48	H2B3S1B	61.95	.44
0.9	112	105	144	WQ6B1S1B	14.65	.17
1.4	114	108	144	WS6B1S1B	21.32	.22
2.4	112	106	144	U6B1S1B	27.53	.22
6.0	110	103	144	WW6B1S1B	44.46	.28
0.9	130	122	168	WQ7B1S1B	16.57	.17
1.4	133	126	168	WS7B1S1B	24.56	.22
2.4	131	123	168	U7B1S1B	31.29	.22
6.0	129	120	168	WW7B1S1B	50.97	.28

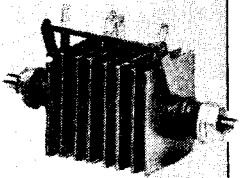

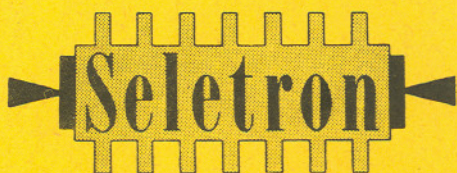

SELENIUM RECTIFIERS

RADIO RECEPTOR COMPANY, Inc.



Since 1922 in Radio and Electronics



Sales Department: 251 West 19th St., New York 11, N. Y.

Factory: 84 North 9th St., Brooklyn 11, N. Y.

Reprinted by courtesy of Service Magazine